

# Coastal Restoration Project Overview, Delivery, and Implementation

2022 COASTAL INDUSTRY WEEK  
WEBINAR SESSION 1

RUDY SIMONEAUX, CPRA CHIEF OF ENGINEERING



# Overview

INDUSTRY DAY BACKGROUND AND HISTORY.....AND INDUSTRY WEEK

CPRA PROJECT DELIVERY

CONTRACTING OVERVIEW AND UPDATE

PAST AND CURRENT PROJECT SUCCESS

# Coastal Industry Day



# 11 Years of Collaboration

PROJECT FORECASTING

INDUSTRY FEEDBACK

TECHNICAL DISCUSSIONS

COLLABORATION AND NETWORKING

PUTTING "A FACE TO A NAME"

CPRA-Coast Builders Coalition Coordination Meeting			
LOCATION: Louisiana State Library, Capital View Room, Baton Rouge, LA		DATE: September 7, 2011	
NAME	REPRESENTING	PHONE	EMAIL
Rudy Simoneaux	CPRA	225-342-0981	rudy.simoneaux@la.gov
Phillip Parker	NOAA	225-576-9341	phillip.parker@noaa.gov
Jerry Carroll	CPRA	225-342-1346	jerry.carroll@la.gov
Dona Ours	CPRA	225-342-6749	dona.ours@la.gov
Molly Bourgoigne	CPRA	225-342-6703	molly.bourgoigne@la.gov
Travis Byland	CPRA	225-342-4491	Travis.Byland@la.gov
Jacob Haffner	CPRA	225-342-0981	Jacob.Haffner@la.gov
JOE GUILLORY	CPRA	225-342-4485	JOSEPH.GUILLORY2@la.gov
Catherine Ricks	CPRA	225-842-0931	catherine.ricks@la.gov
Anna Wojtanowicz	CPRA	225-342-4473	anna.wojtanowicz@la.gov
Jessica Addison	CPRA	225-342-4623	jessica.addison@la.gov
Dan Hussin	Manson Construction	904-973-1651	Dhussin@mansonconstruction.com
Tye Fitzgerald	CPRA	225-342-4496	Tye.Fitzgerald@la.gov
Jim Pire	Kiewit	817-319-0104	Jim.Pire@kiewit.com
Scott Kirtz	Coast Builders Coalition	225-989-7353	skirtz@nickersonderson.com
Kyle Breaux	CPRA	504-280-1005	kyle.breaux@la.gov
Alex Gonzalez-Rodiles	CPRA	225-342-4626	alex.gonzalez-rodiles@la.gov
Gordon Thomson	Shaw-CP&E	561-361-3172	gordon.thomson@shawgrp.com
Bart Sount	GZI	337-139-8504	Bart.Sount@zinc.com
Russ Joffrion	CPRA-ENGR.	225-342-6850	russ.joffrion@la.gov
ANTHONY (TONY) RISKO	MWH	310 729 4216	anthony.risko@mwhglobal.com
Neil McLellan	HDR	713 2566362	neil.mclellan@HDRinc.com
Bill Hanson	GLDD	630 574 3469	whanson@gldd.com
ANCEIL TAYLOR	BE&N	504 587 8700	ATAYLOR@CF&EN.com
MAAIL SICKLES	WEEKS	703 608 2637	msickles@weeks.marine.com
BRETT GEESEY	HDR	557-266-2344	BRETT.GEESEY@HDRINC.COM
Pam Gonzalez	HDR	337-266-2341	Pamela.Gonzales@hdrinc.com
CHUCK BROUSSARD	WEEKS MARINE INC.	985-875-2500	CBROUSSARD@WEEKSMARINE.COM
Jeff Sapia	MWH	225-926-3991	jeffrey.sapia@mwhglobal.com
Mitch Andrus	Royal	337-456-5357	mandrus@royalengineering.net
RICHIE SWEENEY	NCMA		

# Coastal Industry Week

TECHNICAL WEBINARS ON COASTAL PROJECT DESIGN TOPICS

CPRA CONTRACTING OVERVIEW/”DOING BUSINESS WITH CPRA”

SEDIMENT DIVERSION PROGRAM UPDATE

BUSINESS-TO-BUSINESS NETWORKING EVENT

CONSTRUCTION PROJECT FORECAST/INDUSTRY BRIEFINGS

# 2022 CPRA COASTAL INDUSTRY WEEK

## Coastal Industry Week Webinars

**Session 1 – Tuesday, March 29 (12–1pm)**

*Coastal Restoration Project Overview, Delivery, and Implementation*

**Session 2 – Wednesday, March 30 (12–1pm)**

*Access and Logistical Constraints and Solutions for Marine Construction in Coastal Zone*

**Session 3 – Thursday, March 31 (12–1pm)**

*Coastal Restoration Project Geotechnical Analysis, Design, and Construction*

**Session 4 – Friday, April 1 (12–1pm)**

*Mid-Basin Sediment Diversion Program Update*

## Coastal Day 2022

**Session 5 - Monday, April 4 (3–4:30pm)**

*Construction Project Forecast – Partner Projects*

**Session 6 - Tuesday, April 5 (3–4:30pm)**

*Construction Project Forecast – CPRA Projects*

## Business to Business Networking Event

When: Tuesday, April 5

Time: 11:00am – 12:00pm

Where: LSU Center for River Studies

# CPRA Project Delivery



# Coastal Master Plan

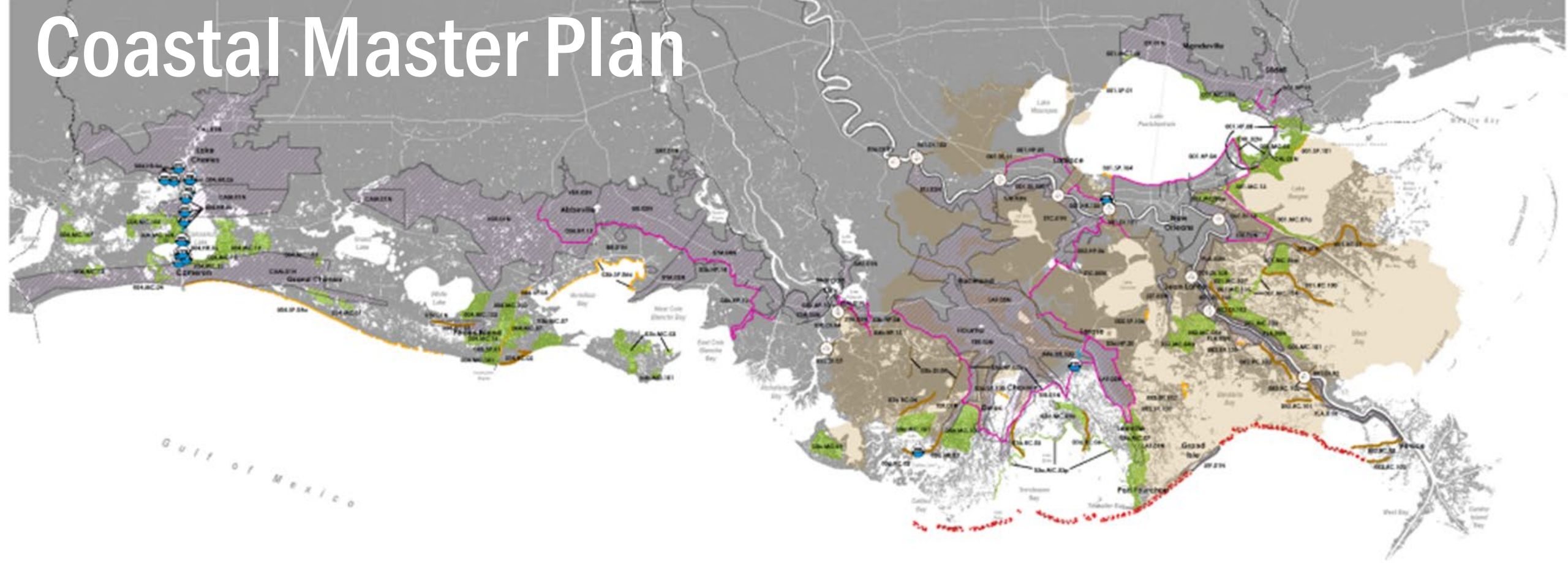

## PROJECT TYPES

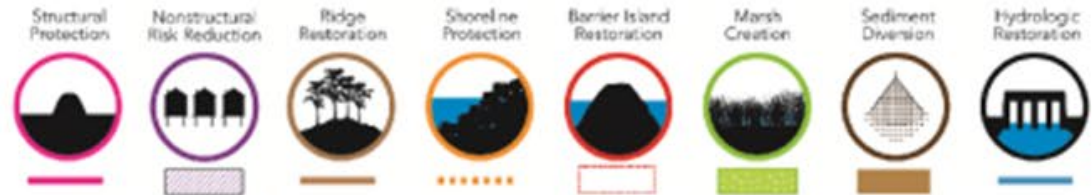

Small scale hydrologic restoration and oyster reef/living shoreline projects are included programmatically in the 2017 Coastal Master Plan. Consistency of individual projects will be determined on a case-by-case basis.

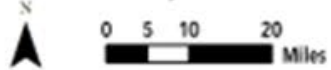



# Coastal Master Plan

# \$50B

 total funding

## RESTORATION

## RISK REDUCTION

# \$25B

# \$25B

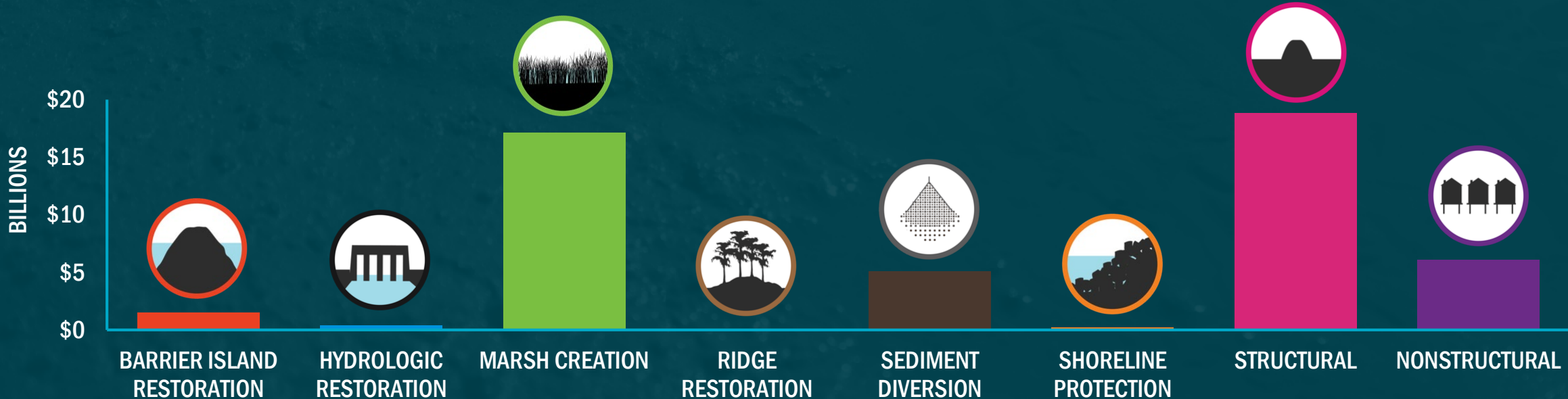

# Coastal Master Plan

SEDIMENT DELIVERY

**\$23.8B**

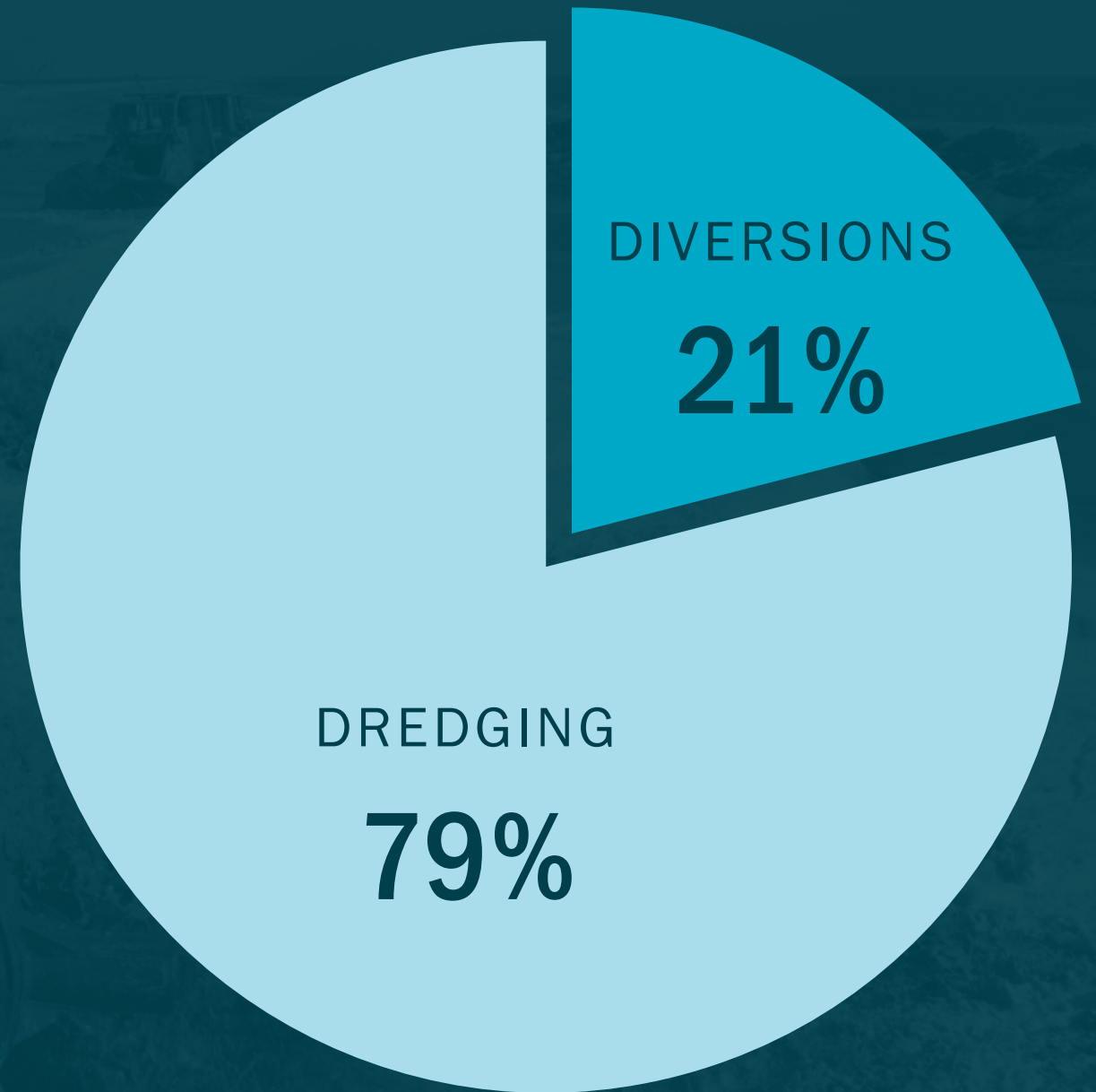

# 101 ACTIVE PROJECTS

PROJECT TYPE	33 CONSTRUCTION	60 E & D	8 PLANNING
Hurricane Protection (24)	14	4	6
Marsh Creation (43)	10	33	
Ridge Restoration ( 2)		2	
Shoreline Protection ( 8)		8	
Barrier Island/Headlands ( 5)	2	3	
Diversions ( 4)		4	
Hydrologic Restoration ( 4)	1	2	1
Oyster Barrier Reef ( 1)	1		
Recreational Use ( 5)	5		
Other ( 5)		4	1

# Shoreline Protection



# Recreational Use Projects



Point Aux Chenes WMA Fishing Piers



Cypremort Point State Park Boardwalks

# Hydraulic Dredging - Cutter Suction



CREDIT: WEEKS MARINE

# Hydraulic Dredging - Cutter Suction



# Barrier Island Restoration





# Barrier Island Restoration

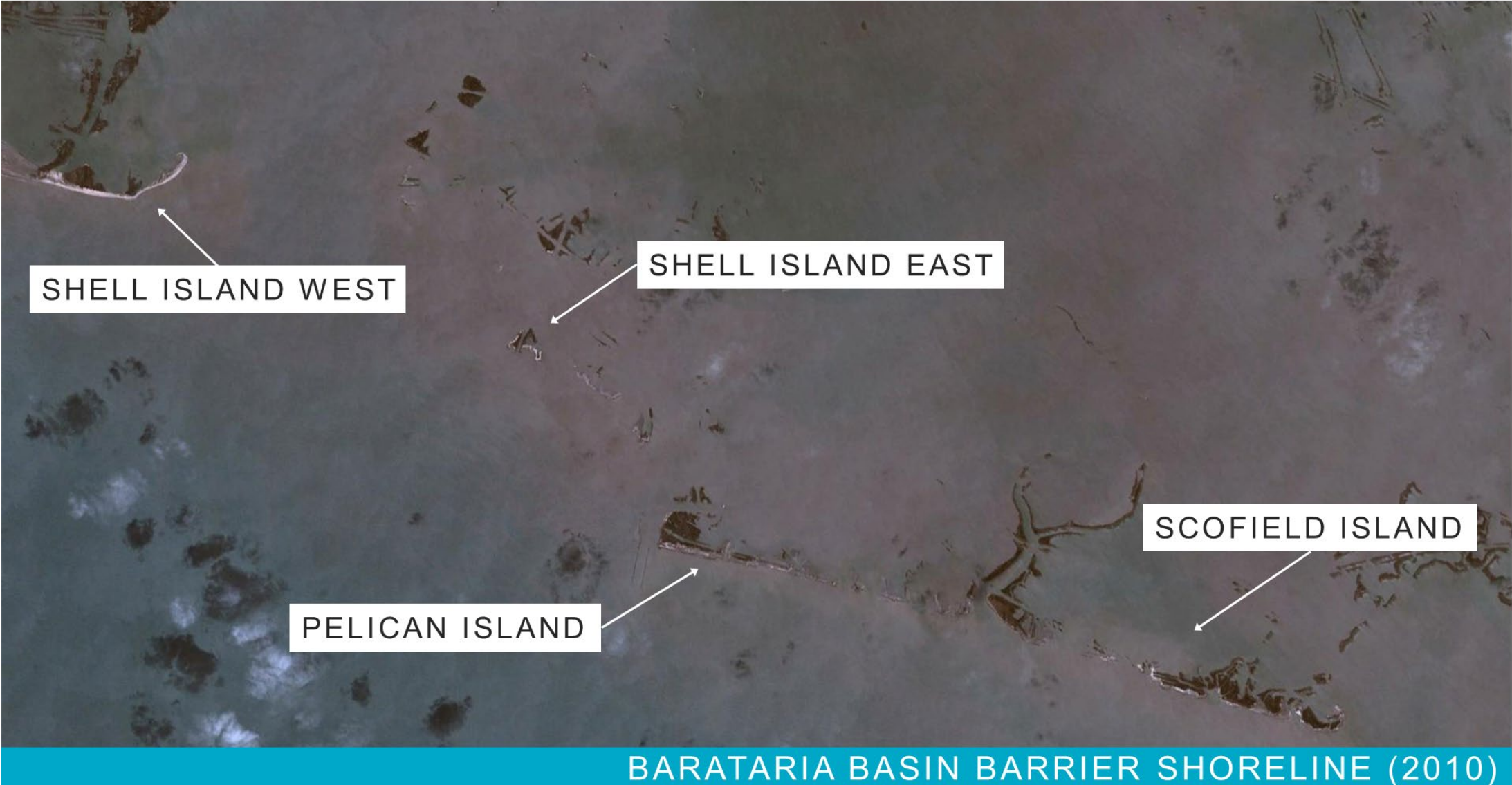

# Barrier Island Restoration





## SHELL ISLAND EAST



## SHELL ISLAND WEST

# Marsh Creation

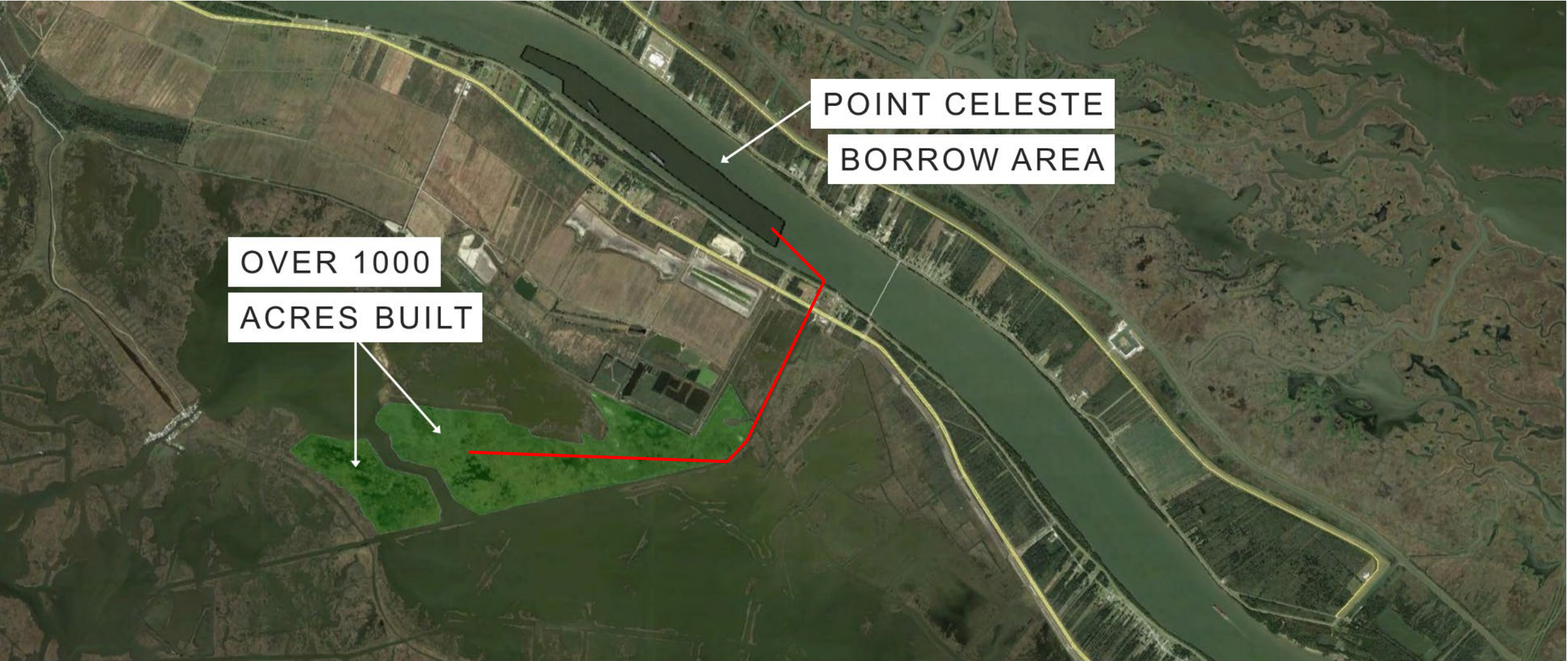

POINT CELESTE  
BORROW AREA

OVER 1000  
ACRES BUILT

LAKE HERMITAGE MARSH CREATION (CONSTRUCTED IN 2015)

# Marsh Creation



# Marsh Creation



LAKE HERMITAGE MARSH CREATION (CONSTRUCTED IN 2015)

# Marsh Creation



LAKE HERMITAGE MARSH CREATION (CONSTRUCTED IN 2015)



# Marsh Creation



LAKE HERMITAGE MARSH CREATION (CONSTRUCTED IN 2015)

# Earthen Containment Dikes

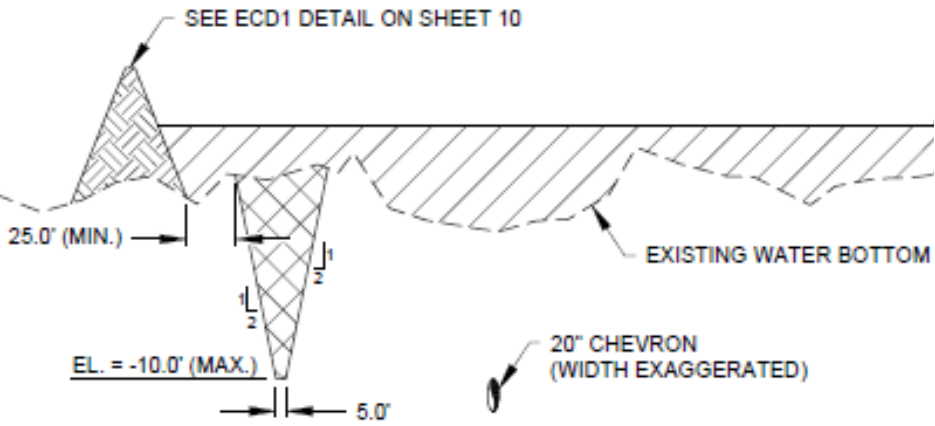

Caminada Headlands Back Barrier Marsh

# CPRA Contracting Overview and Update



# General Contracting Categories

CONSTRUCTION SERVICES

PROFESSIONAL SERVICES

CONSULTING SERVICES

LAND SERVICES

# Construction Services

- Governed by Title 38, Public Bid Law
- Cost-based bid
- Base Bid plus a maximum of three Alternate Bid Items
- Publically advertised and let to the lowest responsible and responsive bidder.

# How to Find Advertisements for Bids

CPRA HOMEPAGE: <https://coastal.la.gov/>

The screenshot shows the CPRA homepage layout. At the top is a blue header with the CPRA logo and name, and a grey navigation bar with links: About CPRA, What's At Stake, Our Plan, Our Work, Press Releases, Resources, and Calendar. Below this is a large teal banner with 'OUR SUCCESS SINCE 2007' and six statistics: \$21.4 BILLION SECURED FOR PROJECTS IN 20 PARISHES, 48,894 ACRES OF LAND BENEFITED, 60 MILES CONSTRUCTED OF BARRIER ISLANDS & BERMS, 157 MILLION CUBIC YARDS OF FILL UTILIZED, 120 ACTIVE PROJECTS, and 336 MILES OF LEVEE IMPROVEMENTS. A red arrow points to the 'RFPs, RSIQs - Contracts' icon in the featured content section below. The featured content includes 'Press Releases' (Gov. Edwards Breaks Ground on HNC Lock Complex), 'Coastal Information Management System' (CIMS), 'RFPs, RSIQs - Contracts', 'Coastal Master Plan', and 'In the News' (Gov. John Bel Edwards helps mark two local storm-protection milestones).

# How to Find Advertisements for Bids

The screenshot shows the CPRA website header with the logo and navigation menu. The main content area is titled "RFPs, RSIQs - Contracts" and contains a red arrow pointing to a blue button labeled "Contracts & Procurement". Below this button are three links: "Click here for information on how to register as a CPRA vendor", "Click here for information on CPRA Contracted Services", and "Click here for Visitor Parking Map".

**Coastal Protection and Restoration Authority**

Sign Up. Stay Informed.  
Email  Zipcode  [Subscribe](#)  
[f](#) [t](#) [@](#) [in](#)

About CPRA What's At Stake Our Plan Our Work Press Releases Resources Calendar

Educational Resources  
Library  
Videos  
RFPs, RSIQs - Contracts  
Hotlist  
Process & Procedures  
Archives

- Bids
- Professional and Consulting Services

Contracts & Procurement  
Professional & Consulting Services  
Public Records Request  
Human Resources

## RFPs, RSIQs - Contracts

As we continue our efforts to protect and restore coastal Louisiana, additional help will be needed. Information about upcoming projects, advertisements for contracts, grants and bids, and additional resources for potential vendors can be found in this section.

If you are having difficulty downloading documents please try using Google Chrome

[Contracts & Procurement](#) [Professional & Consulting Services](#)

[Click here for information on how to register as a CPRA vendor](#)  
[Click here for information on CPRA Contracted Services](#)  
[Click here for Visitor Parking Map](#)

# Professional Services

## Engineering, Geotechnical, Surveying Services

- All data collection efforts (surveying, geotechnical) contracted through IDIQ Task Orders
- Most engineering/design related work contracted through IDIQ Task Orders
- Large-scale design efforts may involve project-specific solicitations and contracts (i.e., diversion design contracts)



# Professional Services

## Engineering, Geotechnical, Surveying Services

- Typically acquired through Request for Solicitation of Interest and Qualifications (RSIQ)/Request for Qualifications (RFQ)
- Can be awarded to one or more firms
- May be project-specific or for Indefinite Delivery / Indefinite Quantity (IDIQ) contracts.
- 3-year term max (currently have staggered start/end contract times)

# Professional Services IDIQ Contracts

## Current IDIQ Quantity and Value

- 33 Engineering Contracts
  - 20 General Engineering Services (\$2M)
  - 6 Coastal Engineering Services (\$2M)
  - 7 Limited Engineering Services (\$1M)
- 7 Geotechnical Services (\$1.5M)
- 7 Surveying (\$1M)

# Professional Services IDIQ Contracts

## Current IDIQ Usage:

Category	Contract Value	Amt. Tasked	%
Engineering	\$65,000,000	\$30,942,506	48%
Geotech	\$10,500,000	\$4,514,710	43%
Surveying	\$7,000,000	\$6,124,589	87%

# Professional Services IDIQ Contracts

## Staggered Contract Terms

- Expired Aug 2021: 14 Engineering, 2 Geotech, 3 Surveying
- Jan 2020 – Dec 2022: 6 Engineering, 7 Limited, 2 Geotech, 1 Surveying
- Sept 2020 – Aug 2022\*: 9 Engineering, 3 Geotechnical, 3 Surveying
- Sept 2021 – Dec 2022\*: 11 Engineering, 2 Geotechnical, 3 Surveying

\*Option to Extend One Year

# Professional Services IDIQ Contracts

## Proposed Change:

- Starting with the Spring 2022 advertisement, CPRA will advertise for Professional Services IDIQ Contracts once every 3 years, with contracts having a 3-yr term. Term for the 2022 advertisement will be Jan 2023 through Dec 2025
- RSIQ to be posted by Q2 2022
- Reevaluate the optimum capacity (quantity and value) for all contract types (engineering, surveying, and geotechnical)

# Professional Services IDIQ Contracts

## FAQs for upcoming IDIQ solicitation:

Q: What specific qualifications/skillsets is CPRA looking for when selecting firms for IDIQ contracts?

A: The majority of CPRA's design work is related to hydraulic dredging. Therefore, an understanding of how hydraulically dredged soils behave, as well as the bidding and construction of these projects, is generally desired. A strong understanding of geotechnical and hydraulic design/analysis within the coastal zone is also scored favorably.

# Professional Services IDIQ Contracts

## FAQs for upcoming IDIQ solicitation:

Q: What type work would be expected on an IDIQ task order?

A: Most of the engineering/design task orders pertain to restoration work (marsh creation, shoreline protection, ridge restoration, barrier island restoration). Task orders may be issued for complete design services (preliminary through bidding) or for design support only. Tasks for construction administration/supervision are also commonly executed.

# Professional Services IDIQ Contracts

## FAQs for upcoming IDIQ solicitation:

Q: Can a firm submit a Statement of Interest and Qualifications (SIQ) as a Prime and also be a subcontractor under another Prime submitting?

A: No. Firms electing to submit a SIQ as a Prime contractor cannot be listed as a Subcontractor on another firm's SIQ. Firms not submitting as Prime contractor are allowed to be listed as a Subcontractor on as many SIQs as they deem appropriate. Firms will need to determine whether they will compete as a Prime or a Subcontractor under the listed RSIQ.



# Professional Services IDIQ Contracts

## FAQs for upcoming IDIQ solicitation:

Q: Can a firm submit a SIQ as a Prime for multiple categories (for example, can a firm submit as a Prime for both the Coastal and General Engineering categories)?

A: Yes. A firm can elect to submit as a Prime on any or all of the five separate solicitations (General, Coastal, Limited, Surveying, Geotechnical). However, a firm can not submit as a Prime and also as a subcontractor in the same solicitation.

# Professional Services IDIQ Contracts

## FAQs for upcoming IDIQ solicitation:

Q: How many Professional Services contracts will CPRA award for each category?

A: It is anticipated that the number of Surveying and Geotechnical will generally remain the same. A reduction in the number of Engineering category (Coastal, General, Limited) contracts is likely. CPRA is currently evaluating upcoming Engineering and Design expenditures to determine the optimum number of Engineering category contracts.

# Consulting Services

## Environmental, Science, Planning

- Project Specific or Indefinite Delivery/Indefinite Quantity (IDIQ)
- Acquired through Request for Proposals (RFP); includes cost as a factor in the scoring of a proposal
- 3-year term, 3 year solicitation schedule (some have staggered start and end dates)

# Consulting Services IDIQ Contracts

## Environmental, Science, Planning

- 10 current IDIQ contracts
- Total contract value - \$30M
- Recently awarded new contracts; contracts start in Spring/Summer 2022

# Hudson/Veteran Initiative Preference

- Small and emerging businesses shall be included in business offerings for state procurement and public contracts
- Points for inclusion of Hudson and/or Veteran Firms included in CPRA Solicitations
- Details on available points vary by solicitation; **always read solicitation carefully**

# How to Find RSIQ & RFP Solicitations

CPRA HOMEPAGE: <https://coastal.la.gov/>

 **Coastal Protection and Restoration Authority**

Sign Up. Stay Informed.  
Email  Zipcode  [Subscribe](#)

[f](#) [t](#) [i](#) [in](#)

- About CPRA
- What's At Stake
- Our Plan
- Our Work
- Press Releases
- Resources
- Calendar

**OUR SUCCESS** | SINCE 2007

<b>\$21.4 BILLION</b> SECURED FOR PROJECTS IN 20 PARISHES	<b>48,894</b> ACRES OF LAND BENEFITED
<b>60 MILES CONSTRUCTED</b> OF BARRIER ISLANDS & BERMS	<b>157 MILLION</b> CUBIC YARDS OF FILL UTILIZED
<b>120</b> ACTIVE PROJECTS	<b>336</b> MILES OF LEVEE IMPROVEMENTS

● ● ● ● ●

**Press Releases**

Gov. Edwards Breaks Ground on HNC Lock Complex, Announces Completion of Grand Bayou Floodgate  
*November 8, 2021*

 Coastal Information Management System

 RFPs, RSIQs - Contracts

 Coastal Master Plan

**In the News**

Gov. John Bel Edwards helps mark two local storm-protection milestones  
*November 8, 2021*



# How to Find RSIQ & RFP Solicitations

The screenshot shows the CPRA website header with the logo and navigation menu. The main content area is titled "RFPs, RSIQs - Contracts" and includes a sidebar with various resource categories. A red arrow points to the "Professional & Consulting Services" button in the main content area.

**Coastal Protection and Restoration Authority**

Sign Up. Stay Informed.  
Email  Zipcode  [Subscribe](#)  
[f](#) [t](#) [@](#) [in](#)

About CPRA What's At Stake Our Plan Our Work Press Releases Resources Calendar

Educational Resources  
Library  
Videos  
RFPs, RSIQs - Contracts  
Hotlist  
Process & Procedures  
Archives

- Bids
- Professional and Consulting Services

Contracts & Procurement  
Professional & Consulting Services  
Public Records Request  
Human Resources

### RFPs, RSIQs - Contracts

As we continue our efforts to protect and restore coastal Louisiana, additional help will be needed. Information about upcoming projects, advertisements for contracts, grants and bids, and additional resources for potential vendors can be found in this section.

If you are having difficulty downloading documents please try using Google Chrome

[Contracts & Procurement](#) [Professional & Consulting Services](#)

[Click here for information on how to register as a CPRA vendor](#)  
[Click here for information on CPRA Contracted Services](#)  
[Click here for Visitor Parking Map](#)

# Past and Current Project Success





# Current Dredging Contracts

Project Name	Parish	Project Lead	Estimated Volume (cubic yards)
North Breton Island (USFWS)	Plaquemines	USFWS	5,890,000
Terrebonne Basin Barrier Island – Hydraulic	Lafourche, Terrebonne	CPRA	9,000,000
Caminada Headland Back Barrier Marsh Creation	Lafourche	CPRA	2,500,000
Cameron Meadows Marsh Creation and Terracing	Cameron	CPRA	1,900,000
West Grand Terre Beach Nourishment and Stabilization	Jefferson	CPRA	5,200,000
Bayou DeCade Ridge and Marsh Creation	Terrebonne	CPRA	2,800,000
Barataria Basin Ridge & Marsh Creation - Spanish Pass Inc.	Plaquemines	CPRA	10,700,000
Golden Triangle Marsh Creation	Orleans, Saint Bernard	CPRA	4,400,000
Lake Borgne Marsh Creation - Increment One	St. Bernard	CPRA	13,200,000
Large-Scale Barataria Marsh Creation - Upper Barataria Inc.	Jefferson, Plaquemines	NOAA	7,000,000
New Orleans Landbridge Shoreline Stabilization & M.C.	Orleans	CPRA	1,100,000
Lake Lery Marsh Creation – Phase 2	St. Bernard	St. Bernard	315,000
<i>South Grand Chenier Marsh Creation (bidding)</i>	<i>Cameron</i>	<i>NRCS</i>	<i>875,000</i>
<b>TOTAL CUBIC YARDS:</b>			<b>64,880,000</b>

# Construction Update

**\$100 Million - NRDA funded**

**10.7 million cubic yards of sediment**

**Building 1,700 acres of earthen  
ridge and marsh**

**Extending 7 miles west of Venice**

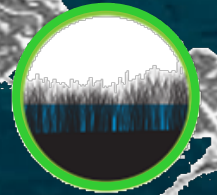

## SPANISH PASS INCREMENT

**BARATARIA BASIN MC & RIDGE PROJECT**

# Spanish Pass MC and Ridge Restoration

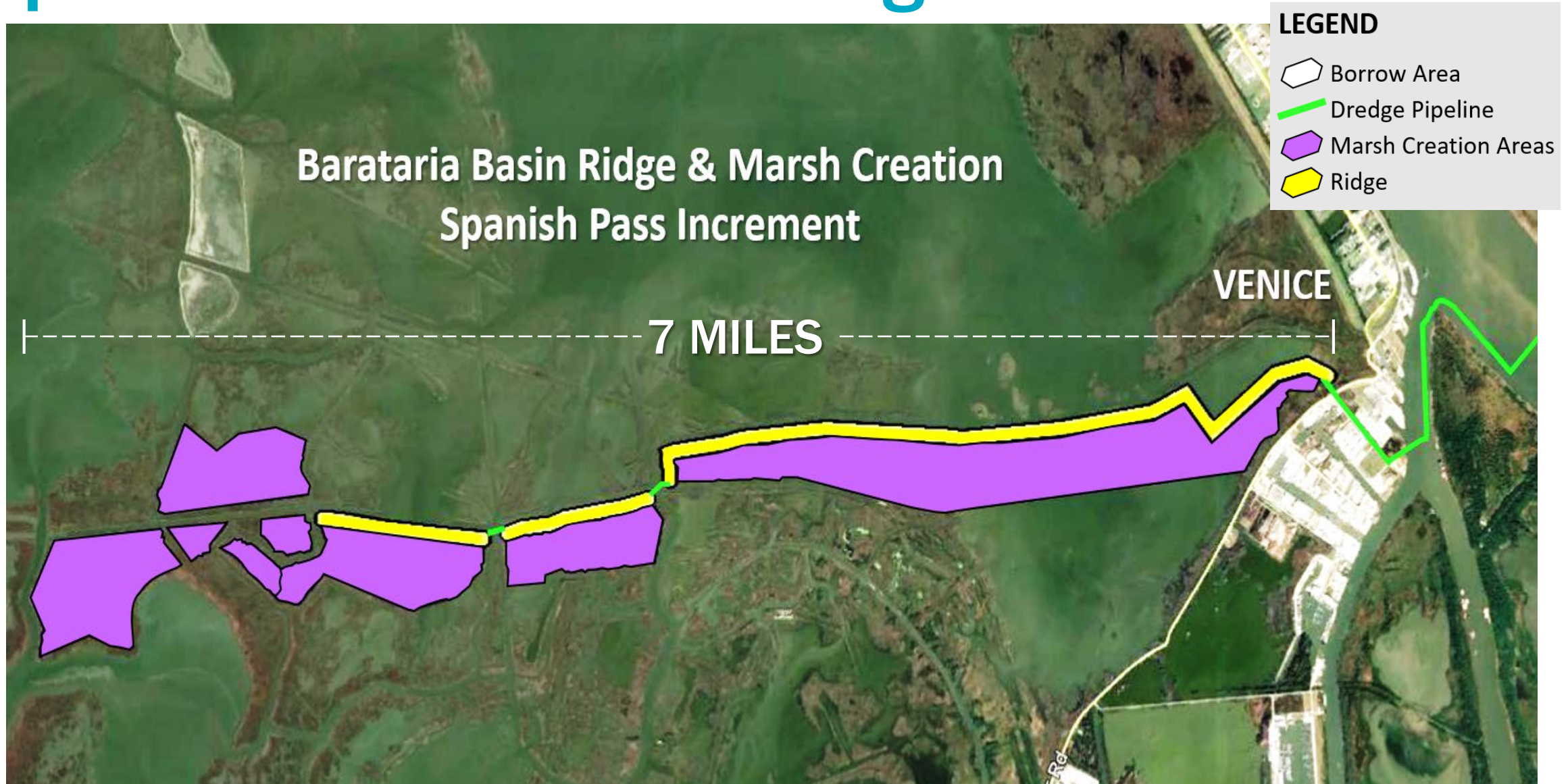

# Construction Update

Creating/Nourishing 473 acres of marsh  
Restoring 11,000 feet of northern ridge  
\$25 million CWPPRA/NOAA (NMFS)

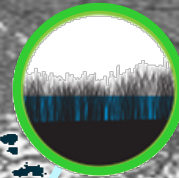

**BAYOU DE CADE**  
**RIDGE & MARSH CREATION**

# Bayou DeCade Ridge and Marsh Restoration

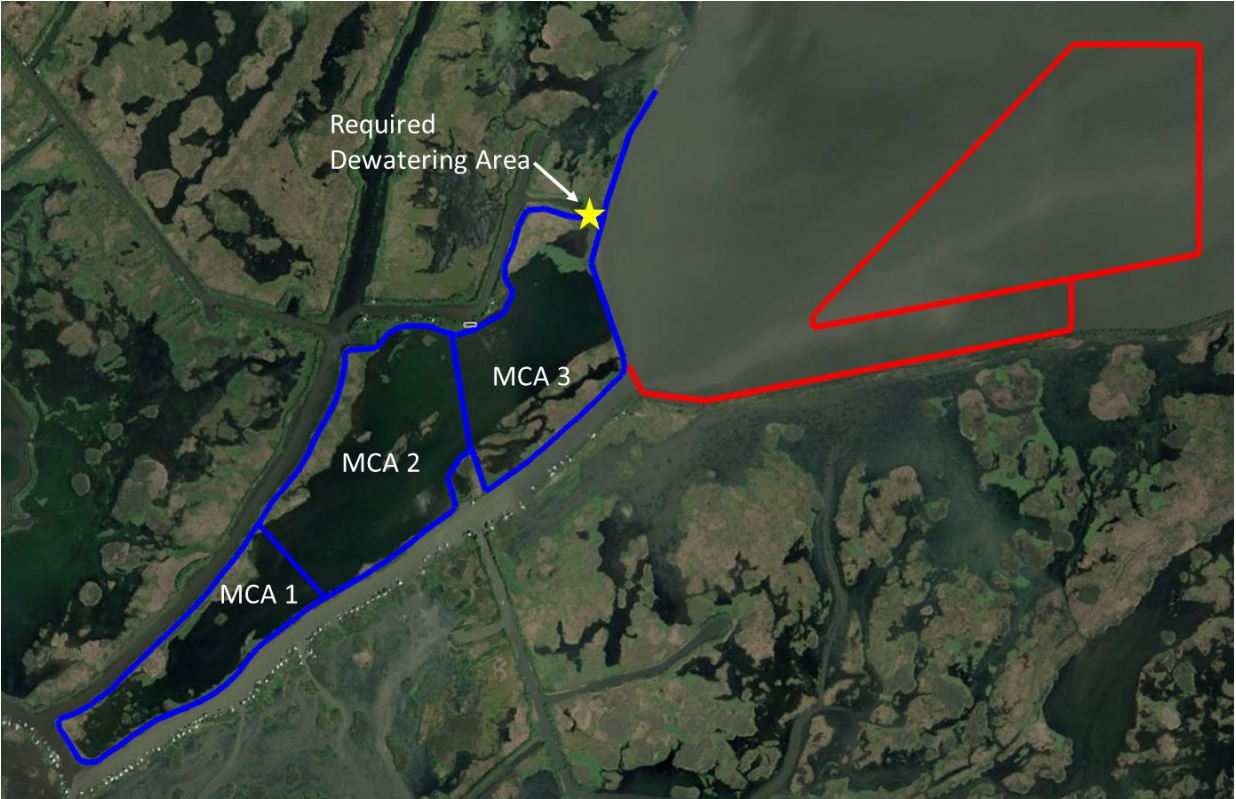

# Construction Update

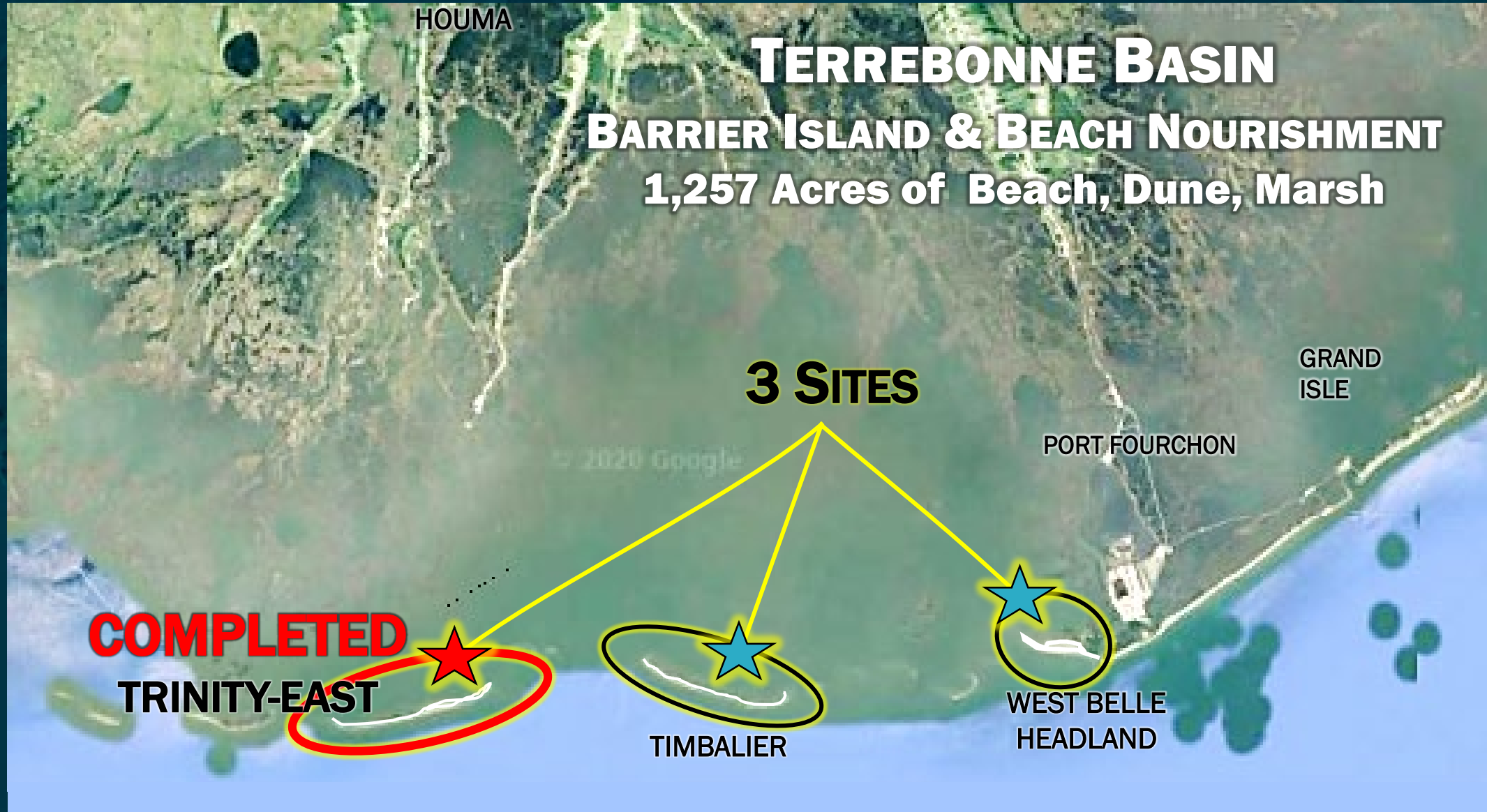

MARCH 29, 2022

# Thank You



**@LouisianaCPRA**

RUDY SIMONEAUX, [RUDY.SIMONEAUX@LA.GOV](mailto:RUDY.SIMONEAUX@LA.GOV)

